

ALINCO

PRIVATE MOBILE RADIO

DJ-446

Instruction Manual

Thank you for buying this ALINCO transceiver.

This instruction manual contains important safety and operating instructions. Please read it carefully before using the transceiver.

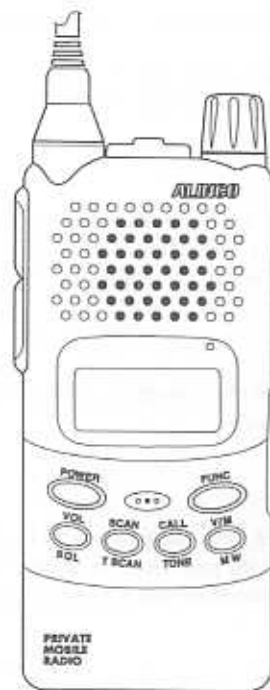

PRECAUTIONS

CAUTION



Do not open the transceiver case or touch non-user-serviceable components.



Do not expose the product to direct sunlight or heat sources. Also, avoid using the product in an extremely dusty or humid environment.



Do not place anything, which might spill on top of or over the product.



Do not yank the power cord from its outlets. Also, do not rewire the power cord with other extension cords. Such handling may damage or short circuit the cord.



Use a 13.8 V DC regulated power supply to operate this product. The transceiver must be grounded.



Beware of moisture condensation.

Moisture in the air will condense on the product when you move it from a cold place to a warm place. Condensation will cause the unit to malfunction. If condensation forms on the unit, wipe or let dry.



For good ventilation, allow about 10 cm between the rear of the product and the wall.



If the product causes harmful interference to VCR or TV reception, move the product away from the appliance.



If the product ever emits smoke or strange smells, immediately turn it off and unplug the power cord. Then, contact your authorized dealer.

CONTENTS

BEFORE OPERATING THE TRANSCEIVER.....	5	4 BASIC OPERATION	13
■ Attention	5	4.1 Turning the Power On.....	13
■ Points to Note Before Transmitting.....	5	4.2 Adjusting the Squelch.....	13
■ Points to Note for Using an External Power Supply.....	5	4.3 Adjusting the Volume.....	14
1 FEATURES	6	4.4 Setting the Frequency in the VFO Mode.....	14
1.1 Accessories.....	6	●Setting the Frequency.....	14
2 ACCESSORIES	6	4.5 Memory Mode.....	15
2.1 Connecting the Accessories.....	6	●Calling Up a Memory Channel.....	15
●Attaching the Hand Strap.....	6	●Writing to a Memory Channel.....	15
●Attaching and Detaching the Belt Clip.....	6	●Deleting a Memory Channel	15
●Attaching and Detaching the Ni-MH Battery Pack.....	6	●Items that can be Stored in Memory.....	16
●Prevent Short Circuiting the Ni-MH Battery Pack	7	4.6 Call Mode	16
●Wall Chager (EDC-94(230V)).....	8	●Changing the Call Channel Frequency	16
●Ni-MH Battery Charge Indicator.....	8	4.7 Receiving.....	16
3 NAMES AND OPERATION OF PARTS	9	●Monitor function	17
3.1 Names and Operation of Parts.....	9	4.8 Transmitting.....	17
3.2 Keypad.....	11	●Switching Transmission Output Level	17
3.3 Display(LCD).....	12	5 USEFUL FUNCTIONS	18
		5.1 Scan Modes.....	18
		●VFO Scan	18
		●Memory Scan	18
		●Setting Skip Channels	18

5.2	Keylock	18			
5.3	Alert Tone or Tone Burst.....	18			
5.4	Naming Memory Channels.....	19			
5.5	Lamp.....	19			
6	COMMUNICATING	20			
■	Selection Calling Method	20			
6.1	Tone Squelch	20			
7	SPECIAL FUNCTIONS.....	21			
7.1	Free Channel Transmitting Function	21			
7.2	Tone Scan Function	21			
8	SET MODE.....	22			
8.1	Set Mode Operation	22			
8.2	Set Mode Setting Method.....	22			
8.3	Functions Set in Set Mode	22			
●	1. Beep Tone ON/OFF	22			
●	2. Standby Beep Setting Function.....	23			
●	3. BELL Setting.....	23			
●	4. Clock Shift Setting	23			
●	5. Battery Save Function ON/OFF	23			
●	6. TOT time	23			
●	7. APO Setting Function	24			
●	8. Alert Tone and Tone Burst Frequency Setting.....	24			
9	CLONING OPERATION.....	25			
9.1	CLONING	25			
10	MAINTENANCE AND REFERENCE.....	26			
10.1	Troubleshooting	26			
10.2	Resetting	27			
10.3	Options	27			
11	QUICK REFERENCE	28			
12	SPECIFICATIONS.....	29			

BEFORE OPERATING THE TRANSCEIVER

■ Attention

- Do not remove the case or touch the interior components. Tampering can cause equipment trouble.
 - Do not use or keep the transceiver where it is exposed to direct sunlight, dusty places, or near sources of heat.
 - Keep the transceiver away from TVs, tuners or other equipment when it interferes with reception.
 - Securely treat the antenna which has been included with the transceiver.
 - For external power, Alinco recommends using the EDC-36 cigarette lighter cable with filter.
 - When transmitting for a long time at high power, the transceiver can overheat.
 - Turn the power off immediately if the transceiver emits smoke or strange odors.
- Ensure the transceiver is safe, then bring it to the nearest Alinco service center.



■ Points to Note Before Transmitting

Many wireless stations use frequencies adjacent to the some bands for business purposes. Be mindful when transmitting near them.

Even when some stations obey radio laws, unexpected jamming can occur.

Pay sufficient attention during mobile operation.

⚠ CAUTION

Depending on laws in different region, it may be forbidden to use the transceiver in the following place :

- Aboard aircraft
- In airports
- In ports
- Within or near the operating area of business wireless stations or their relay stations.

Before use in any of the above places, obtain any necessary permission from the proper authorities and be mindful of local laws that govern radio operation,

■ Points to Note for Using an External Power Supply

- Use a 7.0V-16.0V DC power supply as an external power supply.
- When connecting the power supply to the transceiver, use an optional DC cable for base station (EDC-37). Connect the cable to the DC jack on the side of the transceiver.
- When the power is supplied from a cigarette socket of a car, use the cigarette lighter cable with filter (EDC-36). Use the cigarette lighter cable with filter (EDC-36) during mobil operation to prevent noise.
- Turn the power off when connecting or disconnecting the DC cable.

1 FEATURES

This transceiver has the following features.

- 39 CTCSS tone squelch functions
- Tone scan function
- TOT function can be set to the Duty Cycle that best accommodates the user's requirements
- Namable Memory Channels
- Alert Tone function
- Free channel transmitting function
- Bell function

1.1 Accessories

- Ni-MH battery pack EBP-50N (9.6V 700mAh)
- EDC-94 (230V AC) Wall charger
- Belt clip
- Hand strap
- Instruction Manual
- Warranty**

** Accessories may differ depending on the version you bought.

2 ACCESSORIES

2.1 Connecting the Accessories

● Attaching the Hand Strap



- Attach the hand strap as shown in the illustration on the left.

● Attaching and Detaching the Belt Clip

- Attaching the Belt Clip
Attach the belt clip to the back of the transceiver until it clicks.



- Detaching the Belt Clip
Push up the catches of the belt clip, and pull it.



● Attaching and Detaching the Ni-MH Battery Pack

• Attaching the Ni-MH Battery Pack

Align with the grooves on the transceiver, and slide in the direction of the arrow until it clicks.

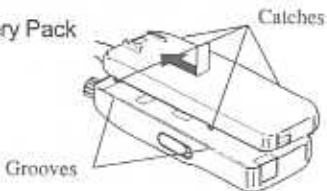

• Detaching the Ni-MH battery pack

Push up the catches, and pull the battery pack or free of the transceiver.

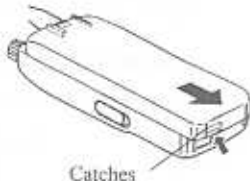

⚠ CAUTION

- The battery pack is not charged when shipped, must be charged before use.
- It takes 12 hours maximum to fully charge the battery pack with the EDC-94.
- Charging should be conducted in a temperature range or 0°C to 40°C. (32°F-104°F)
- Do not modify, dismantle, incinerate or immerse the battery pack in the water as this can be dangerous.
- Never short-circuit the battery pack terminals, as this can cause damage to the equipment or lead to heating of the battery which may cause burns
- Unnecessary prolonged charging (overcharging) can deteriorate battery performance.

- The battery pack should be stored in a dry place where temperature is from -20°C to +45°C. (-4°F-+113°F) Temperatures outside this range can cause the battery liquid to leak. Exposure to prolonged high humidity can cause corrosion of metal components.
- Normally, the battery pack can be charged up to 500 times. However, the battery pack can be considered dead if the period of use drops off markedly despite the pack being charged for the aforementioned charging time. When this happens, a new pack should be used.
- The battery is recyclable. At the end of its useful life, under various national and local laws, it may be illegal to dispose of this battery improperly. Check with your local solid waste officials for details on recycling options or proper disposal in your area.
- When this battery is mounted on the Transceiver, it can be charged by connecting 13.8V DC-IN.

● Prevent Short Circuiting the Ni-MH Battery Pack

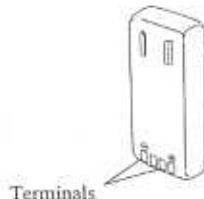

Be extra cautious when carrying the Ni-MH battery pack; short circuiting will produce surge current possibly resulting in fire.

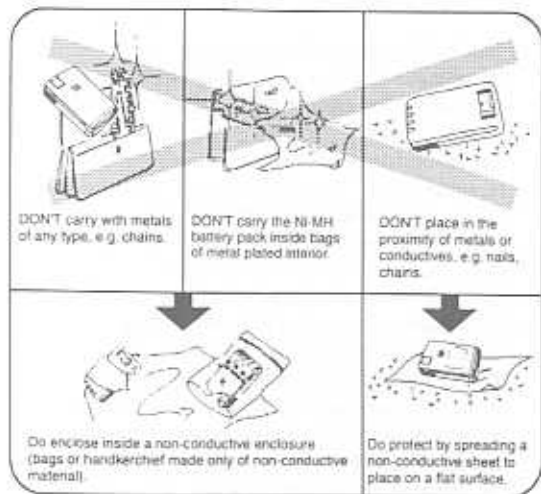

⚠ CAUTION

- Keep the battery pack inside the included pouch when carrying.

● Wall Charger (EDC-94 (230V))

- Recharging with the EDC-94 (230V)



1. Mount the Ni-MH battery pack on the transceiver.
2. Connect AC adapter plug to the external power supply jack on the transceiver.
3. Connect to the AC outlet.

⚠ CAUTION

- Turn the transceiver power off before recharging the battery pack.
- Disconnect the EDC-94 from the outlet while not using it.
- Never charge battery packs of other manufacturers with this charger.
- The required recharging time depends on the condition and model of battery pack. Refer to the instruction manual or the battery pack.
- Never short-circuit the recharging terminals of this recharger with metal objects, etc. The charger can be damaged.
- The EDC-94 does not work when the voltage from the wall outlet is extremely low.
- The EDC-94 can not be used as the external DC cable.

● Ni-MH Battery Charge Indicator

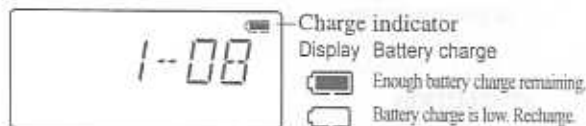

- The battery charge indicator display can vary substantially depending on the ambient temperature and the frequency of use.
- It is still possible to perform LOW output transmission and reception for a period, even when the indicator suggests that recharging is required.

3 NAMES AND OPERATION OF PARTS

3.1 Names and Operation of Parts

● Top and Front

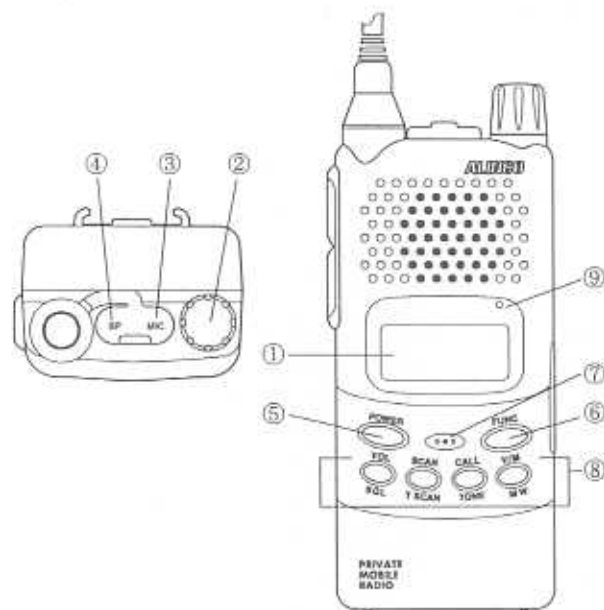

①	Display(LCD)	Refer to "About the display" in this manual.
②	Dial	Rotate the dial to select the transmission/reception channel, memory channel, and tone number, SET mode settings and the characters for memory input for names.
③	Microphone jack	For connection of an external microphone (2k Ω) with ϕ 2.5 stereo plug.
④	Speaker jack	For connection of an external speaker (8 Ω) with ϕ 3.5 mono plug.
⑤	POWER key	Press the POWER key down for approximately 1 sec. to toggle the transceiver on and off.
⑥	FUNC key	The FUNC key is used in combination with the other keys to access the various functions of the transceiver. To enter SET mode to and modify the settings, press the FUNC key continuously for about two seconds.
⑦	Microphone	Speak into the microphone from a distance of about 5cm (2").
⑧	Keypad	Keypad. (see page 11)
⑨	TX / RX lamp	Lights green when the squelch is unmuted. Lights red during transmission.

● Side

3

ANTENNA SIDE

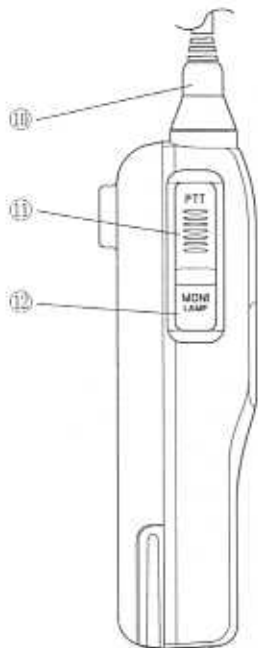





DIAL SIDE



⑩	Antenna	Helical antenna
⑪	PTT key	Press the PTT key to transmit. When you release the PTT key, the transceiver reverts to receiving.
⑫	MONI key	When the MONI key is pressed, the squelch is no longer muted and the received signal is audible. The squelch is no longer muted regardless of the TSQ setting. Pressing the MONI key when the FUNC is displayed activates the key lock function. Pressing the MONI while pressing the PTT key transmits a alert tone signal. Switching the power on while pressing the MONI key switches the lamp on.
⑬	DC-IN jack	Plug for connection of an external power supply. This can be used to power the transceiver from an automobile cigarette lighter using the optional Alinco EDC-36 cable (with filter). The jack polarity is + in the center and - on the outside. When using an external power supply, it should have a voltage output in the range DC7.0V to DC16.0V, 2A (min.), and be regulated.

3.2 Keypad



KEY		While F appear after the FUNC key is pressed.
	Enters volume adjustment mode. (page 14)	Enters squelch adjustment mode. (page 13)
	Enters scan mode. (page 18)	Enters tone scan mode. (page 21)
	Accesses call channel (page 15)	Setting the tone squelch. (page 20)
	Switches between VFO mode and memory mode. (page 14)	Writes to memory. (page 15)

3.3 Display (LCD)

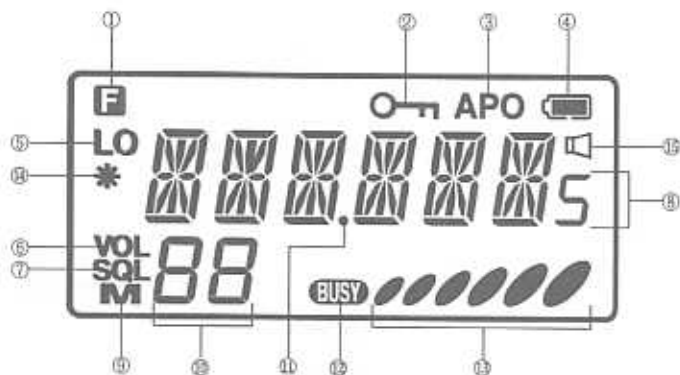

①		Appears when key is pressed.	⑨		Displayed when in Memory mode.
②		Displayed when the frequency or the keypad is locked.	⑩		Displays the memory channel No. and the various setting levels.
③	APO	Appears when Auto Power Off function is activated.	⑪	.	Displays the frequency and scan operation.
④		Battery charge indicator.	⑫	BUSY	Appears when the squelch is unmuted.
⑤	LO	Displayed when the transmission output is LOW.	⑬		Indicates the receiving level and transmission output level.
⑥	VOL	Display when the volume is being adjusted.	⑭	*	Displayed when the BS function is off.
⑦	SQL	Displayed when the squelch is being adjusted.	⑮		Displayed when the BELL function is on.
⑧		Displays the transmission/reception channel and the content of the various settings.			

4 BASIC OPERATION

4.1 Turning the Power On



Hold the  key down for a second.



To turn the power off, hold the  key down until the indication disappears.

4.2 Adjusting the Squelch

The squelch silences the transceiver except for signals above a certain level. Squelch eliminates the noise when the transceiver receives less than a certain level.

"To unmute the squelch" means that the transceiver receives the signal and reproduces the sound.

- There are 21 squelch levels (00–20).
- The default setting is Level 00.

1. Press the  key, while **F** is displayed on the LCD, and then press the  key. "SQL" and the squelch level are displayed on the LCD.

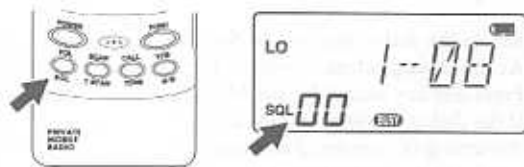

2. Rotate the dial to increase or decrease the squelch level. At large setting values, the squelch unmutes at strong signal levels.
3. Press any key except for the MONI key to complete setting.
4. If the dial is not operated for a period of about five seconds, the setting is completed automatically, and the transceiver returns to the normal display.

4.3 Adjusting the Volume

- There are 21 volume levels (00–20).
 - The default setting is Level 00.
- There is no audio when the setting is 00.

1. Press the  key. "VOL" and the volume level are displayed on the LCD.

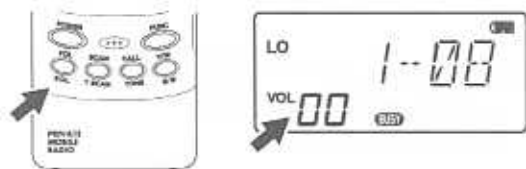



2. Rotate the dial to increase or decrease the volume level. As the setting values increases, the volume becomes louder.
3. Press any key except for the MONI key to complete setting. If the dial is not operated for a period of about five seconds, the setting is completed automatically, and the transceiver returns to the normal display.

4.4 Setting the Frequency number in the VFO Mode.

The factory setting for the transceiver is the VFO mode. The VFO mode allows you to change the frequency number and other settings.

●Setting the Frequency Number

Press the  key to enter VFO mode. The transceiver toggles between VFO mode and Memory mode each time the  key is pressed.



"M" is displayed on the LCD when the transceiver is in Memory mode, and nothing is displayed when the transceiver is in VFO mode.

- Rotate the Dial clockwise one click to increase the frequency number
- Rotate the Dial counter-clockwise one click to decrease it.

4.5 Memory Mode

This mode allows you to call up previously stored frequencies. The transceiver has 30 memory channels.

● Calling Up a Memory Channel

1. Press the  key to enter Memory mode. The transceiver toggles between VFO mode and Memory mode each time the  key is pressed.

"M" is displayed on the LCD when the transceiver is in Memory mode, and nothing is displayed when the transceiver is in VFO mode.







2. Rotate the dial to display the memory channel No. that you want.

Clockwise rotation : each click increases the memory channel No. by one.

Counter-clockwise rotation :
each click decreases the memory channel No. by one.

● Writing to a Memory Channel



1. Press the  key to enter VFO mode.
2. Select the frequency number that you want to write, and tone function as required.
3. Press the  key, while **F** is displayed on the LCD, press the  key to enter the memory write mode. When you want to cancel the memory mode, press the PTT key.
4. Select the memory channel number that you want to write. "M" and channel number is flashing.
If the channel number is not flashing, it means the memory channel is being used.
5. Press the  key.

The frequency number is written to the memory channel and an audible completion tone is heard. "M" and channel number is always displayed.

NOTE

- If **[]** is selected for the memory channel, the call channel is also written to.

● Deleting a Memory Channel

1. Press the  key to enter Memory mode.
2. Rotate the dial to select the memory channel No. that you want to delete.
3. Press the  key, while **F** is displayed on the LCD, then press the  key.
4. Repeat the same operation of step 3.

● Items that can be Stored in Memory

The following items can be stored in each of the memory channels (CH1 to 30).

- Frequency number
- Tone number
- Skip channel setting
- Clock shift setting
- Alphanumeric channel tag

IMPORTANT

- It is not possible to use the dial to change the Call mode frequency or memory channel No.
- It is possible to temporarily change the CTCSS settings and operate the unit.
- The Scan function cannot be used when in Call mode.

● Changing the Call Channel Frequency

The call channel is allocated as one memory channel. Therefore, to change the call frequency number or other settings, call up the memory channel from VFO mode or Memory mode (see 4.5 Memory mode, page 15).

IMPORTANT

- The call channel frequency can be modified but not deleted.

4.6 Call Mode

This mode is used to standby on a call channel, or to call up a channel.

The transceiver has one call channel. The initial frequency number setting. (see 10.2 Resetting CALL Frequency number, page 27)

1. Press the  key to enter call mode.



The transceiver will enter call mode and “ [” will appear in the display.



2. Repeating the procedure in step 1 will return the transceiver to VFO mode or memory mode.

Pressing the  key will also return the transceiver to VFO mode or memory mode.

4.7 Receiving

1. Switch the transceiver power on.
2. Press the  key and rotate the dial to increase the volume level as necessary.
3. Press the  key, and a white **F** is displayed on the LCD, press the  key and rotate the dial to the setting at which the noise disappears.
4. Select the frequency number that you want. When a signal is received on the frequency number that you selected, **BUSY** is displayed on the LCD and the received signal is audible.

The green RX indicator is illuminated at this time.

● Monitor function

This function can be used to temporarily switch off the squelch when the received signal is weak or breaking up and is difficult to copy.

- The squelch is unmuted while the MONI key is pressed, regardless of the squelch level setting.
- This function unmutes the squelch even if the Tone Squelch function is set.

4.8 Transmitting

1. Select the frequency number that you want.
2. Press the PTT key.
The red TX indicator will light.
3. While holding down the PTT key, speak into the microphone on the transceiver at normal speaking volume.
4. When you have finished speaking, release the PTT key.

IMPORTANT



- To transmit a alert tone signal, press the MONI key while holding down the PTT key.

● Switching Transmission Output Level

It is possible to change the transmission output level.

Press the  key while holding down the PTT key to toggle between high and low transmission power output. When low transmission power output is selected, "LO" is displayed on the LCD. Nothing is displayed when high power is selected.

The initial setting is low power.

The RF meter display is  when transmitting at low power, and  when transmitting at high power.



5 USEFUL FUNCTIONS

5.1 Scan Modes



This function automatically changes the transceiver frequency number to help you locate the signal you want to receive.

- After scanning stops, if no signal is present, you will hear an audible ringing tone and the transceiver switches to the next channel.
- During scanning, the decimal point (.) on the frequency number display flashes. The monitor function operates.
- Press the  key to stop scanning.
- Scanning is started in the direction of the last dial operation (up or down).

● VFO Scan

1. Press the  key again to enter VFO mode.
2. Press the  key to start scanning.

● Memory Scan

1. Press the  key again to enter Memory mode.
2. Press the  key to start memory scanning.



● Setting Skip Channels

Memory channels that are set as skip channels are skipped during a memory scan.

- Select the desired memory channel, and then power off.
- Power on while pressing the SCAN key.

- The decimal point of front side of the memory channel will appear when the skip channel is programmed to the channel.
- To cancel the skip channel, repeat the programming procedures.

5.2 Keylock

To switch on the keylock function, press the  key, and while the  is displayed on the LCD, press the MONI key.

- When the Keylock function is on, the  mark is displayed on the LCD.
- When the keylock function is on, the PTT and MONI keys are operable, alert tone transmission can be output and the transmission output levels can be changed.
- To switch off the keylock function, repeat the switch on procedures.





5.3 Alert Tone or Tone Burst

- To output the alert tone or tone burst signal, press the MONI key while holding down the PTT key. The initial setting for the alert tone can be changed using the set mode. (☞ Chapter 8 Set Mode, page 24).
- When the Tone is set, the tone frequency is appended to the transmission.



5.4 Naming Memory Channels

In Memory mode, it is possible to display a string of alphanumeric characters (channel name) in place of the frequency number setting.

● Setting Method

1. In Memory mode, select the channel that you want to set a channel name for.
2. Press the  key for at least 5 seconds.
3. [A] flashes on the display.
4. Rotate the dial to select a character for input.
5. Press the  key to input the character. The character will stop flashing.
6. The same character as the one just input is displayed flashing at the position on the right of the last input character.
7. Press the  key to confirm (sequential input).
8. Press the  key during input to delete all input characters.
9. Press the PTT key to complete input and return to the channel name display.

● Using the Channel Name function

- In memory mode, the alphanumeric names set for the channels are displayed in the frequency number display area.
- Press the  key to switch from the channel display to the frequency number display for 5 seconds (pressing the  key during this time reverts to the channel name display)

5.5 Lamp

- Switching the power on while pressing the MONI key switches the lamp on or off

7 SPECIAL FUNCTIONS



7.1 Free Channel Transmitting Function

You can connect to other person without deciding channel setting.

1. Set the volume and squelch to proper position.
2. Set to the same scan mode on both transceiver.
3. To start a call, push the PTT key for a moment in which transceiver.
4. Receiving transceiver can hear a call sound.
5. Both transceiver will be able to communicate each other.
6. Transceiver will return to scan mode after elapsing 5 seconds of no communication.

7.2 Tone Scan Function

If you want to know the receiving tone number, this function will be helpful to you.

1. Receiving a proper signal.
2. Press the  key, and while **F** is displayed on the LCD, press the  key to start the tone scan when receiving a unknown tone signal.
3. Transceiver will be stop on the proper tone number.
4. Pressing the PTT key will complete the setting and return the transceiver to normal states

6 COMMUNICATING



■ Selection Calling Method

- To communicate with a particular station, use either the Tone Squelch function.
The Tone Squelch function unmutes the squelch when one of the 39 tone frequencies set for the transceiver matches the tone frequency of another station.

6.1 Tone Squelch

● Setting the Tone Squelch

- The Monitor function also works while the tone frequency is displayed.

- Press the  key, and while the **F** is displayed on the LCD, press the  key. Tone number is flashing. If you want to cancel the tone squelch, by pressing the  key again, OF (OFF) is displayed on the LCD



- While the tone number is displayed, turn the dial to select the tone number to use from among the standard tone list below.
- Pressing the PTT key will complete the setting and return the transceiver to normal states.

No.	Frequency	No.	Frequency	No.	Frequency	No.	Frequency
1	67.0	11	97.4	21	136.5	31	192.8
2	71.9	12	100.0	22	141.3	32	203.5
3	74.4	13	103.5	23	146.2	33	210.7
4	77.0	14	107.2	24	151.4	34	218.1
5	79.7	15	110.9	25	156.7	35	225.7
6	82.5	16	114.8	26	162.2	36	233.6
7	85.4	17	118.8	27	167.9	37	241.8
8	88.5	18	123.0	28	173.8	38	250.3
9	91.5	19	127.3	29	179.9	39	69.3
10	94.8	20	131.8	30	186.2		

● Tone Squelch Operation

- The squelch is unmuted when the received frequency matches the setting frequency.

8 SET MODE

The set mode is used to set the various operation functions.

8.1 Set Mode Operation



No	Display	Function
1	BEP-ON	Beep on/off
2	STB-ON	Stand-by Beep on/off
3	BEL-OFF	Bell off/on
4	SFT-OFF	Clock Sift off/on
5	BS-ON	Battery save on/off
6	TO-OFF	TOT time set
7	AP-OFF	APO time set
8	ALT	Alert Tone or Tone Burst

- Cut out the following Set Mode Function List, for use as a reference.

REFERENCE(SET MODE)

No	Display	Function
1	BEP-ON	Beep on/off
2	STB-ON	Stand-by Beep on/off
3	BEL-OFF	Bell off/on
4	SFT-OFF	Clock Sift off/on
5	BS-ON	Battery save on/off
6	TO-OFF	TOT time set
7	AP-OFF	APO time set
8	ALT	Alert Tone or Tone Burst

8.2 Set Mode Setting Method

1. Press the  key for at least two seconds.
The transceiver will enter Set mode.
"BEP-ON" is displayed in the initial menu.
 2. Press the MONI key or  key to select a menu.
The Monitor function cannot be used in this state.
 3. Rotate the dial to change the setting contents.
 4. Press the PTT key will complete the setting and return the transceiver to normal display.
- The next time that you enter Set mode, the most recently used setting menu is displayed.

8.3 Functions Set in Set Mode

The following function can be set using the Set mode.

●1. Beep Tone ON/OFF

1. BEP-ON is displayed on the LCD.
2. Rotate the dial to set to BEP-OFF.
3. Each time the dial is rotated, on and off settings are switched repeatedly.

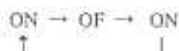

●2. Standby Beep Setting Function

1. STB-ON is displayed on the LCD.
2. Rotate the dial to switch the display as shown below.

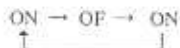

Standby Beep Operation



* Each communicator hears short a beep when PTT key is released during transmission.

●3. BELL setting Function

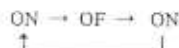
1. BEL-OF is displayed on the LCD.
2. Rotate the dial to switch the display as shown below.



BELL operation

- *  is displayed on the LCD when BELL function is set ON. By setting ON, you can hear a bell sound and  flashes, when receiving proper signal.
-  stops flashing when you press the PTT key.

●4. Clock Shift Setting

1. SFT-OF is displayed on the LCD.
2. Rotate the dial to switch the display as shown below.

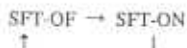

Clock Shift Operation

- In the unlikely event that CPU noise exists on a particular operation frequency programmed into the radio, you can shift the CPU clock frequency to avoid the CPU clock noise, which normally is so soft that it is inaudible even if the radio is turned exactly to its frequency.

●5. Battery Save Function ON/OFF

1. BS-ON is displayed on the LCD.
2. Rotate the dial to switch the display as shown below.

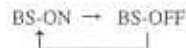

BS Operation

- This function saves battery consumption by switching the reception circuit power supply on/off using a fixed ratio if there is no key operation or signal reception for five consecutive seconds or more.
- *  is displayed on the LCD when BS function is turned off.

●6. TOT Time

1. TO-OFF is displayed on the LCD.
2. Rotate the dial to switch display as shown below.

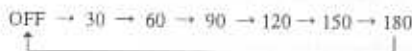

TOT Operation

- If the continuous transmission time approaches the programmed time, a beep sounds five seconds before the time is up. Then the transceiver enters the receiving mode automatically. In this case, unless the PTT key is turned off, the next transmission is deactivated.

●7. APO Setting Function

1. AP-OFF is displayed on the LCD.
2. Rotate the dial to switch the display as shown below.

OFF → 30 → 60 → 90 → 120
↑

APO Operation

- When APO is displayed on the LCD, if no operation is performed for approximately 30 minutes, a beep will sound and power of the transceivers will automatically be turned off. To turn the transceiver back on, set the power switch on again.

●8. Alert Tone and Tone Burst Frequency Setting

1. ALT is displayed on the LCD. ALT means a normal alert tone.
2. Rotate the dial to switch the display as shown below. Then the tone frequency will be changed

ALT → 1000 → 1450 → 1750 → 2100
↑

9 CLONING OPERATION

9.1 CLONING

With the Cloning function, it is possible to connect two transceivers by a cable, and copy all settings from one unit to the other (including memory data).

● Connection Method

- Connect the speaker jacks of the sending transceiver and the receiving transceiver using a ϕ 3.5 stereo mini-plug cord as shown in the diagram.
- Be certain that both units are switched off before connecting them.

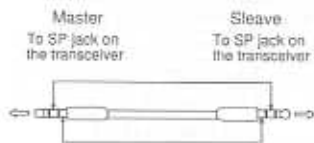

- After connecting the units, switch them both on.
- #### ● Master and Slave Transceiver Operation
1. For the master and slave transceiver, press the PTT key three times while holding down the MONI key. "CLONE" is displayed on the LCD of both the transceivers and the transceivers enter Clone mode.



2. In this mode, press the PTT key on the master transceiver. SD*** is displayed on the LCD of the master transceiver, and the internal settings of the master transceiver are transferred to the slave transceiver.

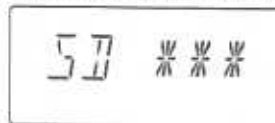

3. After the transfer is completed, "PASS" is displayed on the LCD of the master transceiver.

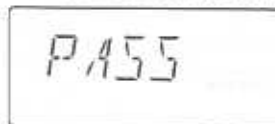

4. Switch to power off to cancel Clone mode.

⚠ CAUTION

- Do not disconnect the cable during data transmission.
- When data transfer is performed using the Clone function, all settings in the slave unit are overwritten by the master unit settings. Take due care.

10 MAINTENANCE AND REFERENCE



10.1 Troubleshooting



Please check the list below before concluding that the transceiver is faulty. If a problem persists, reset the transceiver. This can sometimes correct erroneous operation.

Symptom	Possible Cause	Action
Nothing appears on the display when you turn the power on.	Poor Ni-MH battery pack connection.	Check that the battery pack terminals are clean.
	Battery is run down.	Recharge battery.
	You are releasing the key too quickly.	Hold the POWER key down longer.
No speaker audio. No reception.	Volume too low.	Adjust the volume.
	Squelch level too high.	Adjust the squelch.
	Tone squelch is on.	Turn off tone squelch.
	You are pressing the PTT key and transmitting.	Release PTT key.
Frequency display is incorrect.	CPU error.	Reset.
	A channel name is set.	See Naming Memory Channels function.
Won't scan.	Squelch is unmuted.	Set squelch so that noise is just muted.
Frequency and memory number do not change.	Keylock is on.	Turn off keylock.
	Transceiver is in the call mode.	Go to VFO mode or memory mode.
Key entry not possible.	Keylock is on.	Turn off keylock.
Cannot transmit. Display flashes or goes out when you transmit.	Battery is run down.	Recharge battery.
Cannot transmit. Not replay when you transmit.	Not pressing PTT key firmly enough.	Press the PTT key and confirm that TX/RX lamp lights red.
	Incorrect frequency.	Match your frequency to receiving station frequency.
The display flashes or disappears during reception.	Battery is run down.	Recharge battery.

10.2 Resetting

When you reset the transceiver, all settings are returned to the initial factory settings. Existing memory channel settings will be lost.

1. Switch on the power by pressing the  key while holding down the  and  key.
2. All of the LCD segments are displayed.

Release the  and  keys. The initial mode for the transceiver is VFO mode.

Factory settings

	DJ-446
VFO Frequency Number	1
CALL Frequency Number	1
Memory Channel	1-30ch Blank
Tone Number	8
Key Lock	Off
Time Out Timer	Off
Auto Power Off	Off
Volume Level	0
Squelch Level	0

10.3 Options

- EBP-51N Ni-MH battery pack (9.6V DC 1500mAh)
- EDC-36 Mobile Cigarette lighter adapter with active noise filter
- EDC-37 External DC supply cable
- EDC-97 Quick charger (with AC adapter)
- EMS-9 Speaker microphone
- EMS-51 Speaker microphone
- EME-6 Earphone
- EME-12 Headset with VOX
- EME-13 Earphone and mic with VOX
- EME-15 Tie-pin mic with VOX
- EBC-6 Mobile bracket

11 QUICK REFERENCE

11.1 KEY OPERATION

	Pressed alone	While F is displayed	Press, hold and turn the power on	Push for X seconds
F	F Mode ON/OFF	—	RESET (with V/M)	Set Mode ON 2 seconds
MONI	1. Squelch OFF 2. Tone burst or CALL tone while transmitting	Key Lock ON/OFF	Lamp ON/OFF	—
PTT	1. Transmitting 2. Decision of Value	—	—	—
Power	Power ON/OFF	—	—	—
VOL (SQL)	Volume ADJ. Mode in	Squelch ADJ. Mode in	—	Alphanumeric write mode ON 5 seconds
SCAN (TSCAN)	1. Start SCAN 2. Transmitting power change	Start Tone SCAN	Skip channel setting	—
CALL (TONE)	CALL CH	Tone frequency setting	—	—
VM(MW)	VARI and MEMORY select	MEMORY write	CH. display mode	—
ROTARY ENCODER	VARI and MEMORY UP DOWN	—	—	—

11.2 SET MODE

NO	Display	Function	Select Value	NO	Display	Function	Select Value
1	BEP-ON	Beep on/off	ON-OFF-ON	5	BS-ON	Battery Save on/off	ON-OFF-ON
2	STB-ON	Standby Beep on/off	ON-OFF-ON	6	TO-OFF	TOT time set	OFF-30-60-90-120-150-180-OFF
3	BEL-OFF	Bell off/on	OF-ON-OFF	7	AP-OFF	APO time set	OFF-30-60-90-120-OFF
4	SFT-OFF	Clock Shift off/on	OF-ON-OFF	8	ALT	Alert Tone or Tone Burst	ALT-1000-1450-1750-2100-ALT

12 SPECIFICATIONS

12.1 General

Frequency range	
PMR :	TX/RX 446.00625~446.09375MHz (12.5kHz step 8CH)
Modulation :	F3E(FM)
Frequency step :	12.5kHz
Memory channel :	30 channels + 1call channel
Ant. impedance :	50 Ω unbalanced
Frequency stability :	± 5 ppm
Mic. impedance :	2k Ω
Supply voltage :	7.0~16.0VDC
Current consumption :	0.5W output : approx. 0.5A 280mW rating output : approx. 200mA Squelch reception : approx. 50mA Battery save on : approx. 20mA
Temperature range :	-10°C~+60°C (+14°F~+140°F)
Ground :	Negative ground
Dimension :	56(W) \times 124(H) \times 37.5(D)mm (2.20"(W) \times 4.88"(H) \times 1.48"(D)) (with EBP-50N)
Weight :	Approx. 300g (10.56oz) (with EBP-50N)
Subaudible Tone (CTCSS) :	encoder/decoder installed(39 tones)

12.2 Transmitter

Power output :	Approx. 0.5W Approx. 0.1W (LOW output)
Modulation :	Variable reactance
Spurious emission :	-60dB or less
Max. deviation :	± 2.5 kHz
Mic. impedance :	2k Ω

12.3 Receiver

System :	Double-conversion superheterodyne
Sensitivity :	-12.0dB μ (0.25 μ V) or less
Intermediate frequency :	1st IF 45.1MHz 2nd IF 455kHz
Sensitivity :	-6dB : 6kHz or more -60dB : 13kHz or less
AF output :	280mW (MAX) 200mW (8 Ω , 10% distortion)

THE HISTORY OF THE

...

...

...

...

...

...

...

...

...

...

...

...

...

...

...

...

...

...

...

...

...

...

...

...

...

...

...

...

...

...

...

PRALINCO, INC.

2000
1000
500
0

1000



ALINCO, INC.

Shin-Dai Building 9th Floor
2-6,1-Chome, Dojimahama, Kita-ku, Osaka 530-0004, Japan
Phone:06-4797-2136 Fax:06-4797-2157
E-mail:export@alinco.co.jp

PS0361B